

[□ □



1.2

1.2.1

1.2.3

1-2

			t	

1.2.4

1-3

		t	t				

1.2.5

1.3

1.4

1.5

1.6

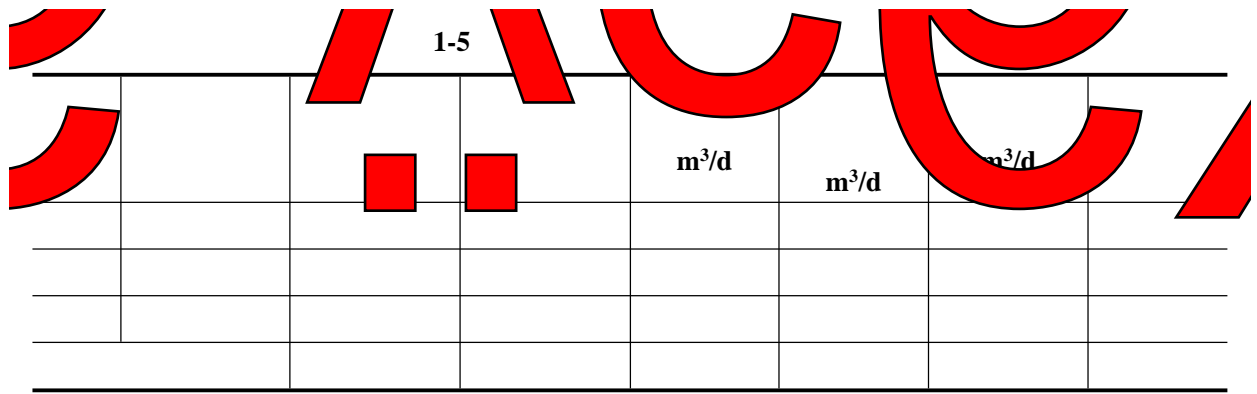

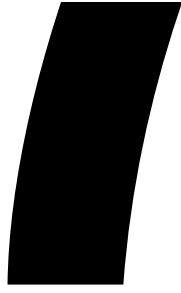

--	--	--	--

—

2.1

2.1.1

2.1.3

2.1.4

2.1.5

2.1.6

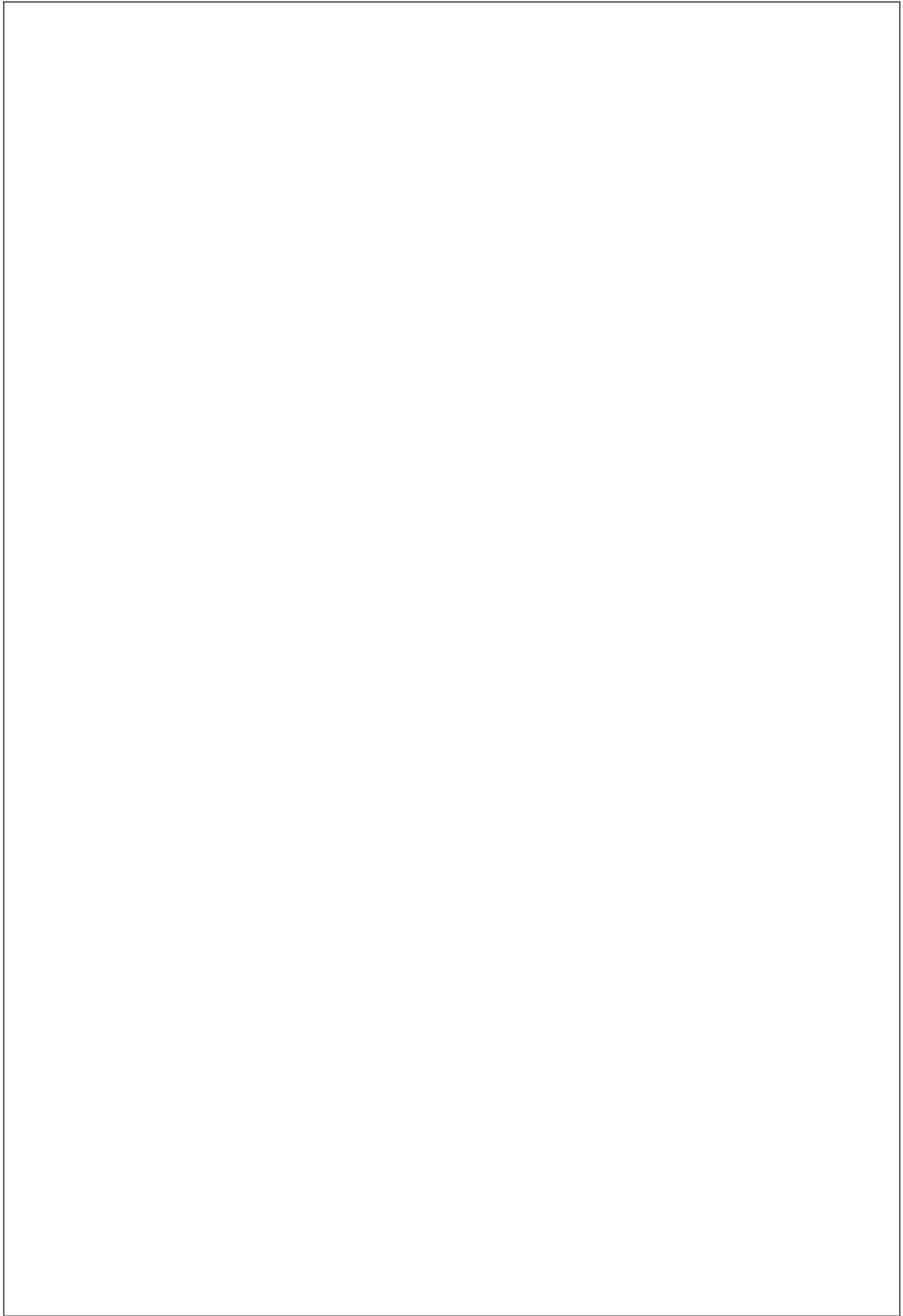

2.2

2.2.1

2.2.2

2.2.3

"

"

"

"

"

"

"

"

3-2

		$\mu\text{g}/\text{m}^3$	$\mu\text{g}/\text{m}^3$	%	

" "

(

3.2

3-4

m

4.1

4-1

mg/m³

1

4-3

	mg/m ³	kg/h	m	mg/m ³	

2

4-4

GB12523-2011

4-5

GB12348-2008

3

4-6

GB31572-2015 mg/L pH

4-7

mg/L pH

	pH	COD	BOD ₅					

4

5

b , Q
h# Q

Q QO, @đ Q&5•5-“€™Đ

4-8

t/a

×

×

×

×

4-9

	t/a	t/a

5.1

5.1.1

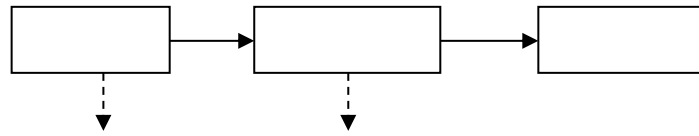

5-1

5.1.2

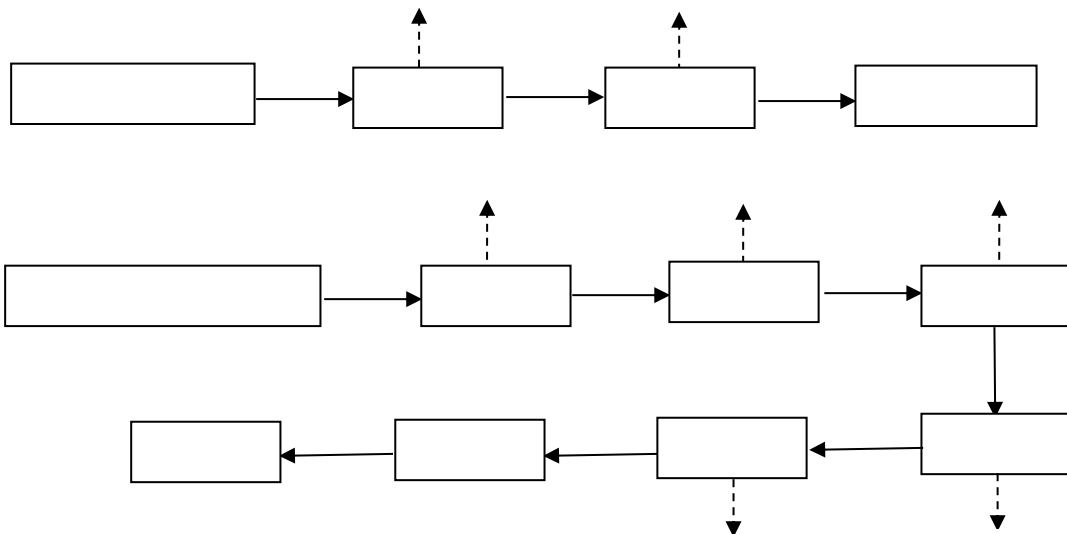

5-2

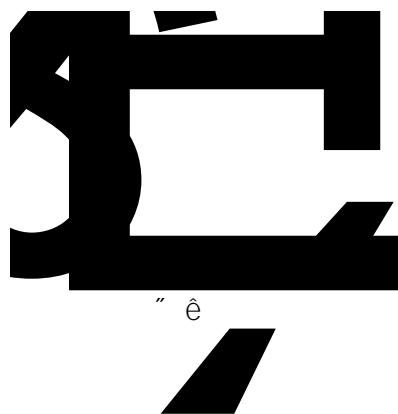

" ê "

d

±

a a

5.2.2

1

5-4

			dBA		dBA

4

5-5

			t/a	t/a	

					0	
					0	
			0			

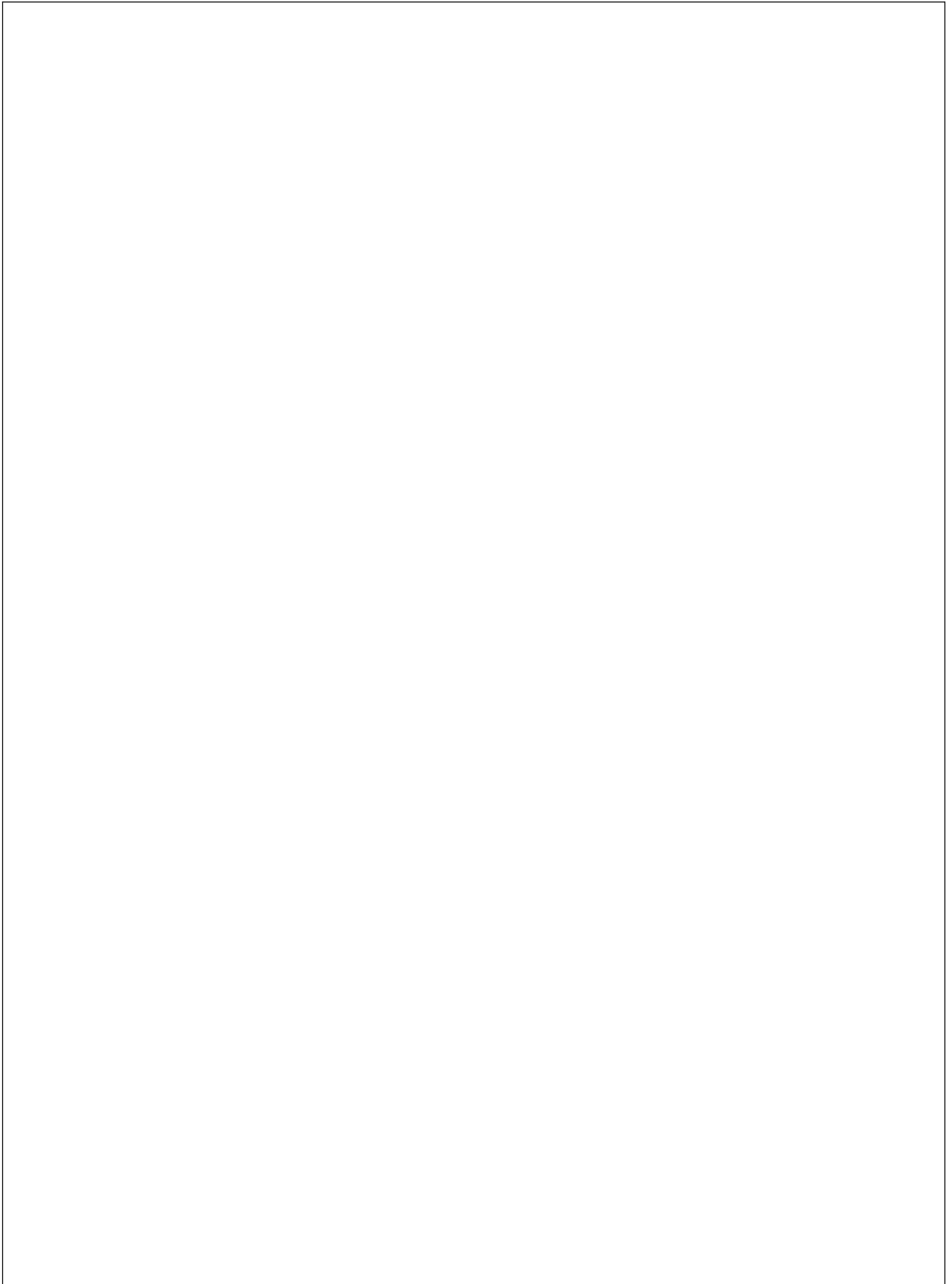

7.1

7.2

7.2.1

1

7-1

				m			
		mg/m ³	kg/h		mg/m ³	kg/h	

7-2

	kg/t		

2

"

"

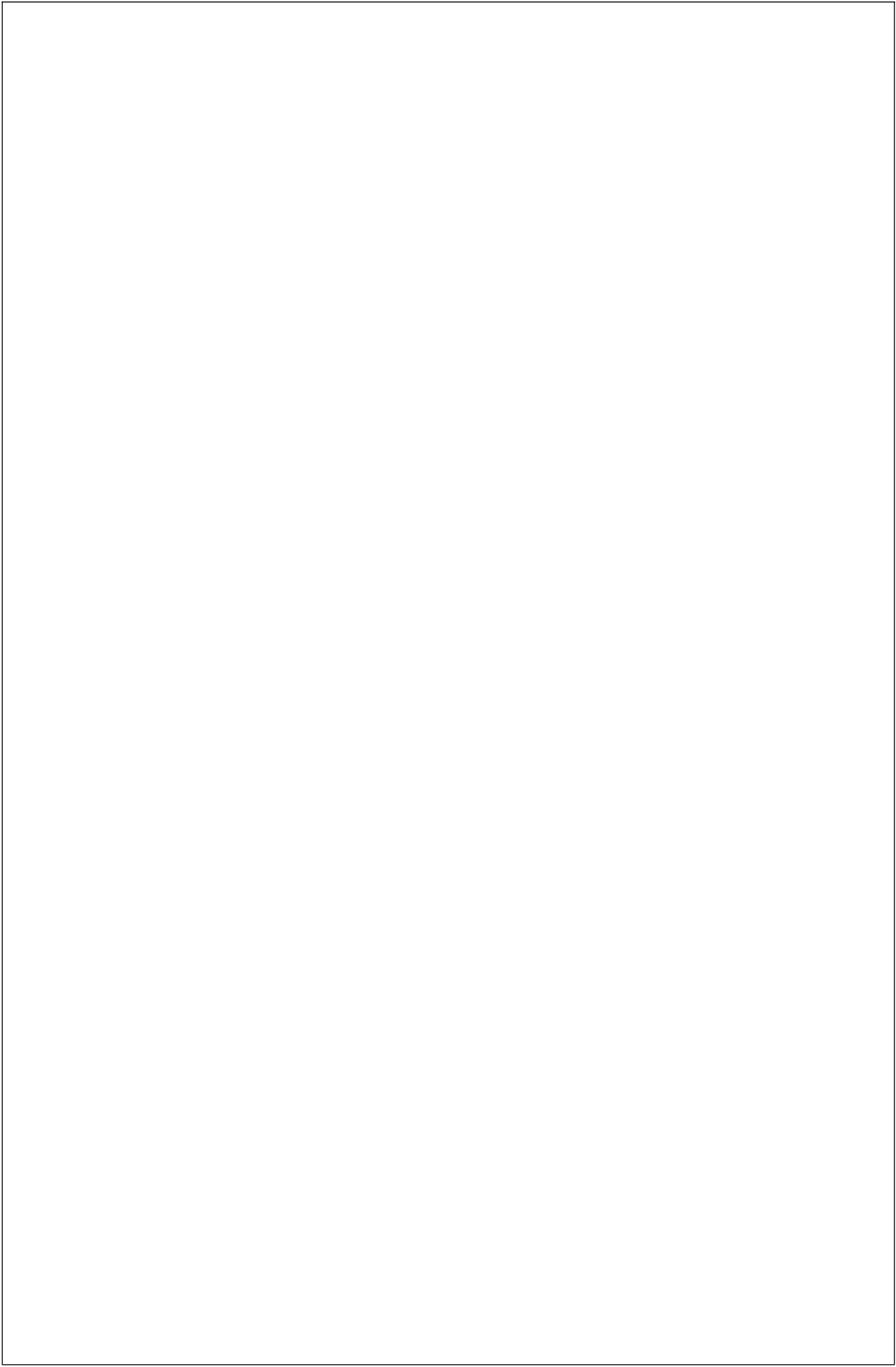

3

7-3

			/(mg/m ³)	

7-4

7-5

										kg/h	
X	Y		m	m	m/s	K	h	—		VOCs	

7-6 AERSCREEN

VOCs

D m / **µg/m³** /% / **µg/m³** /% / **µg/m³** /%

--	--	--	--

7-7

			<i>C</i> $\mu\text{g}/\text{m}^3$	<i>P</i> %	<i>m</i>	<i>C</i> $\mu\text{g}/\text{m}^3$

"

" "

"

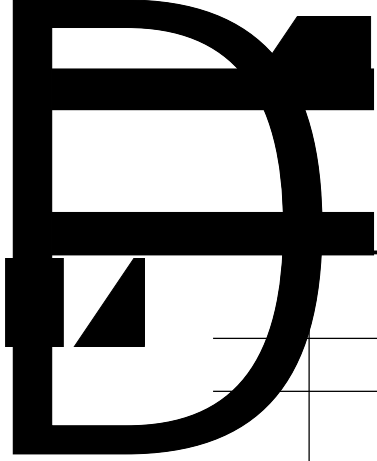

7-8

		$\mu\text{g}/\text{m}^3$	(kg/h)	(t/a)

7-12

7-12									
				/(t/a)					
									/(mg/L)

7-13

7-13				
				/(mg/L)

7-14

			/ mg/L	/ t/d	/ t/a
				---	---

7-15

		⊗

		⊗		
		⊗		
		⊗		

$$L(r) = L(r) - (r \cdot r) - \Delta L$$

$$L(r)$$

$$L(r)$$

$$r$$

$$\Delta L$$

$$r$$

$$L_c = \sum_{i=1}^n l_i$$

$$L_c$$

$$n$$

$$L_i \quad i$$

$$L_{eq} = (L_{ai} + L_{ax})$$

$$L_{eq}$$

$$L_{ai} \quad i$$

$$L_{ax}$$

7-17

		m		dB A	

7-18

dB(A)

注：项目夜间不生产。

7.2.4

7-19

			t/a	t/a	
		--			

1

2

3

4

7-20

7.3

7.3.1

7-21				Q		
		(t)	GB18218 (t)		qn/Qn	

7-22

	+			

7.3.2

7.3.3

7.3.3.1

7-23

7.3.3.2

7-24

2

/

7.3.5

7.3.5.1

7.3.5.2

—

—

—

ϱ

ϱ

ϱ

ϱ

ϱ

7-28

7.7

7-29 “ ”

9.1

9.1.1

9.1.2

9.1.3

9.1.4

9.1.5

9.1.6

9.1.8

"

"

"

"

"

"

9.1.9

9.1.10

